

Modulation of excitatory synaptic transmission by Δ^9 -tetrahydrocannabinol switches
from agonist to antagonist depending on firing rate

Alan M. Roloff and Stanley A. Thayer

Department of Pharmacology, University of Minnesota Medical School
Minneapolis, MN 55455

Running Title: THC switches from agonist to antagonist depending on firing rate

Corresponding author: Stanley A. Thayer, Department of Pharmacology, University of Minnesota, 6-120 Jackson Hall, 321 Church Street, Minneapolis, MN 55455, USA

Tel.: +1-612-626-7049; Fax: +1-612-625-8408; E-mail: sathayer@umn.edu

Text: 26 pages

Tables: 0

Figures: 6

References: 40

Abstract: 209 words

Introduction: 519 words

Discussion: 1465 words

Abbreviations: THC, Δ^9 -tetrahydrocannabinol; , Win55212-2, [(R)-(+)-[2,3-dihydro-5-methyl-3[(4-morpholinyl)methyl] pyrrolo[1,2,3-de]-1,4-benzoxazinyl]-(1-naphthalenyl)methanone mesylate salt]; 2-AG, 2-arachydonylglycerol; EPSC, excitatory postsynaptic current; IPSC, inhibitory postsynaptic current; CB1R, cannabinoid type 1 receptor; VGCC, voltage-gated calcium channel; GPCR, G-protein coupled receptor; eCB, endocannabinoid; DMEM, Dulbecco's modified Eagle's media; DSE, depolarization-induced suppression of excitation; I_{Ca} , calcium current; AM251, N-(Piperidin-1-yl)-5-(4-iodophenyl)-1-(2,4-dichlorophenyl)-4-methyl-1H-pyrazole-3-carboxamide; ISI, inter-sweep interval; CNS, central nervous system.

Abstract

Δ^9 -Tetrahydrocannabinol (THC), the principle psychoactive ingredient in marijuana, acts as a partial agonist on presynaptic CB1 cannabinoid receptors to inhibit neurotransmitter release. Here we report that THC inhibits excitatory neurotransmission between cultured rat hippocampal neurons in a manner highly sensitive to stimulus rate. THC (1 μ M) inhibited excitatory postsynaptic currents (EPSCs) and whole-cell I_{Ca} evoked at 0.1 Hz but, at 0.5 Hz THC had little effect. The cannabinoid receptor full agonists Win55212-2 (100 nM) and 2-arachidonylglycerol (1 μ M) inhibited EPSCs independent of stimulation at 0.1 or 0.5 Hz. THC occupied CB1 receptors at 0.5 Hz, but the receptors failed to couple to presynaptic Ca^{2+} channels. Consequently, 1 μ M THC blocked the inhibition of EPSC amplitude by Win55212-2 when EPSCs were evoked at 0.5 Hz. A depolarizing prepulse to 0 mV reversed THC inhibition of I_{Ca} but, reversal of the inhibition produced by Win55212-2 required a pulse to +80 mV, suggesting that the voltage-dependent reversal of $G\beta\gamma$ inhibition of voltage-gated Ca^{2+} channels accounts for the frequency dependence of cannabinoid action. THC blocked depolarization-induced suppression of EPSCs evoked at 0.5 Hz, indicating that it inhibited retrograde endocannabinoid signaling in a frequency-dependent manner. Thus, THC displayed a state-dependent switching from agonist to antagonist that may account for its complex actions in vivo.

Introduction

Δ^9 -Tetrahydrocannabinol (THC), the active agent in the medication dronabinol and the principal psychoactive ingredient in marijuana, exerts its effects on the central nervous system (CNS) via cannabinoid type 1 receptors (CB1R) (Chaperon and Thiebot, 1999). CB1R are G protein-coupled receptors (GPCRs) that activate K^+ channels and mitogen activated protein kinases and inhibit adenylyl cyclase and voltage-gated Ca^{2+} channels (VGCCs) (Howlett, 2005). The short-term inhibition of synaptic transmission by cannabinoids is primarily mediated by inhibition of presynaptic VGCCs (Brown et al., 2004). Endocannabinoids (eCBs) produced by postsynaptic neurons diffuse in the retrograde direction where they too, act on presynaptic CB1R to inhibit excitatory and inhibitory synaptic transmission (Lovinger, 2008). The effects of THC on synaptic transmission and eCB signaling are not entirely explained by it simply mimicking eCBs.

THC is a partial agonist of CB1R as indicated by weak stimulation of GTP- γ S binding in rodent brain (Breivogel and Childers, 2000) and modest inhibition of excitatory postsynaptic currents (EPSCs) (Shen and Thayer, 1999). The CB1R antagonist rimonabant completely blocked THC-mediated inhibition of glutamatergic synaptic transmission. THC produces a sub-maximal response even at concentrations that saturate CB1Rs; thus, THC will attenuate the actions of full agonists, including eCBs (Kelley and Thayer, 2004). In addition to its low intrinsic activity, THC is highly lipophilic, which imbues it with properties incompatible with many experimental techniques including poor washout and insufficient penetration of brain slices (Lovinger, 2008; Lundberg et al., 2005). Thus, more water soluble full CB1 agonists such as [(R)-(+)-[2,3-dihydro-5-methyl-3[(4-morpholinyl)methyl] pyrrolo[1,2,3-de]-1,4-benzoxazinyl]-(1-naphthalenyl)methanone mesylate salt] (Win55212-2) are widely used for in vitro studies (Eissenstat et al., 1990). However, the recreational and clinical use of THC provides a compelling reason to study this compound specifically. In the few studies to examine the acute

effects of THC on synaptic transmission, the magnitude of the responses varied widely (Shen and Thayer, 1999; Straiker and Mackie, 2005). The low intrinsic activity of THC confers a high sensitivity to CB1R density (Selley et al., 2001). However, there is another important aspect to cannabinoid action that might explain the varied effects reported for THC.

Increases in firing rate will overcome the inhibition of neurotransmitter release produced by activation of presynaptic GPCRs (Brenowitz et al., 1998; Frerking and Ohliger-Frerking, 2006). Indeed, the presynaptic inhibition produced by Win55212-2 is attenuated at high firing rates (>20 Hz) (Foldy et al., 2006). Because THC is widely used in humans, has weak and variable effects on synaptic transmission and has potentially complex interactions with the eCB signaling system, we examined the effects of firing rate on the presynaptic inhibition produced by THC.

Here, we tested the hypothesis that increases in presynaptic firing rate would attenuate THC-mediated inhibition of excitatory synaptic transmission and that at high firing rates THC would antagonize eCB signaling. Our data indicate that modest increases in stimulus frequency had a profound effect on THC-mediated effects. At low firing rates, THC exhibited classical agonist properties. In contrast, at elevated firing rates THC occupied CB1R, but did not effectively couple to VGCCs and thus, THC acted as an antagonist. This state-dependent switching from agonist to antagonist may account for the complex actions of THC in vivo.

Materials and Methods

Materials. Dulbecco's modified Eagle medium (DMEM) and sera were purchased from InVitrogen (Carlsbad, CA). THC was obtained from the National Institute on Drug Abuse (Research Triangle Institute, Research Triangle Park, NC). Bicuculline methochloride and 2-arachidonylglycerol were purchased from Tocris Cookson (Ellisville, MO). All other reagents were purchased from Sigma (St. Louis, MO).

Cell Culture. Rat hippocampal neurons were grown in primary culture as described previously (Pottorf et al., 2006) with minor modifications. Fetuses were removed on embryonic day 17 from maternal rats, anesthetized with CO₂, and killed by decapitation under a protocol approved by the University of Minnesota Institutional Animal Care and Use Committee in accordance with the National Institutes of Health guide for the care and use of laboratory animals. Hippocampi were dissected and placed in Ca²⁺ and Mg²⁺-free HEPES buffered Hanks' salt solution, pH 7.45. HEPES buffered Hanks' salt solution was composed of the following (in mM): HEPES 20, NaCl 137, CaCl₂ 1.3, MgSO₄ 0.4, MgCl₂ 0.5, KCl 5.0, KH₂PO₄ 0.4, Na₂HPO₄ 0.6, NaHCO₃ 3.0, and glucose 5.6. Cells were dissociated by trituration through a series of flame-narrowed Pasteur pipettes, pelleted and re-suspended in DMEM without glutamine, supplemented with 10% fetal bovine serum and penicillin/streptomycin (100 U/mL and 100 µg/mL, respectively). Dissociated cells then were plated at a density of 10,000–15,000 cells/dish onto a 25-mm-round cover glass precoated with matrigel (250 µL, 0.1mg/mL). Neurons were grown in a humidified atmosphere of 10% CO₂ and 90% air at 37°C, and fed on days 1 and 6 by exchange of 75% of the media with DMEM supplemented with 10% horse serum and penicillin/streptomycin. Cells used in these experiments were cultured without mitotic inhibitors for a minimum of 12 days.

EPSC recordings. 6-Cyano-2,3-dihydroxy-7-nitroquinoxaline-sensitive EPSCs were recorded using the whole-cell configuration of the patch-clamp technique (Kouznetsova et al., 2002). Pipettes (Narishige) with open resistances of 3–5 MΩ were filled with solution that

contained (in mM): K-gluconate 120, KCl 15, MgCl₂ 6, EGTA 0.2, HEPES 10, Na₂ATP 5, pH 7.3 with KOH, 290 mOsm/kg. Recordings were performed at room temperature (22 °C) in an extracellular solution that contained (in mM); NaCl 140, KCl 5, CaCl₂ 9, MgCl₂ 6, glucose 5, HEPES 10, bicuculline methochloride 0.01, pH 7.4 with NaOH, 325 mOsm/kg. Solutions were applied by a gravity-fed superfusion system. Membrane potential was held at -70 mV and monosynaptic EPSCs evoked with a bipolar platinum electrode (FHC Inc, Bowdoinham, ME) placed near a presynaptic neuron. Voltage pulses (0.1 ms) were applied at a fixed rate of either 0.1 Hz or 0.5 Hz using a Grass S44 stimulator with a SIU-5 stimulus isolation unit (Astro-Med Inc., West Warwick, RI). For DSE recordings, EPSCs were evoked at 0.5 Hz. DSE was elicited by depolarizing the postsynaptic cell to 0 mV for 15 s followed by continued recording at 0.5 Hz. A second DSE was elicited 5 min after the first response.

VGCC recordings. Whole-cell I_{Ca} recordings were performed using pipettes filled with (in mM); CsMeSO₄ 145, HEPES 10, BAPTA 10, MgATP 5, Na₂GTP 1, pH 7.35 with CsOH, 315mOsm/kg. Seals were formed in; NaCl 140, KCl 5, CaCl₂ 9, MgCl₂ 6, glucose 5, HEPES 10 pH 7.4 with NaOH, 325 mOsm/kg and then switched to buffer to isolate I_{Ca} that contained (in mM); TEACl 143, CaCl₂ 5, MgCl₂ 1, HEPES 10, Glucose 10, 0.1% bovine serum albumin, pH 7.4 with TEAOH, 325 mOsm/kg. Series resistance was compensated by a minimum of 75%. Membrane potential was held at -80 mV and currents evoked by stepping to 0 mV for 40 ms every 2 or 10 s (0.5 or 0.1 Hz) as noted. Recordings were not corrected for leak as there was essentially no current at the 0 mV test potential in the presence of 200 μM Cd²⁺. For tail current recordings, membrane potential was stepped in 10 mV intervals from -40 mV to +70 mV for 20 ms followed by repolarization to -40 mV for 20 ms with the resultant tail current peak amplitude analyzed after subtracting leak current measured in 200 μM Cd²⁺. Voltage-dependent reversal of cannabinoid inhibition of I_{Ca} was tested by comparing a control current evoked by stepping from -80 mV to 0 mV for 40 ms to a current evoked 500 ms later following a 40 ms pre-pulse to

either 0 mV or +80 mV. Voltage sensitivity of cannabinoid inhibition was also assayed using paired 20 ms steps from -80 mV to 0 separated by a 10 ms return to -80 mV.

Data Acquisition and Analysis. Currents were amplified using an Axopatch 200A; for EPSC and I_{Ca} recordings respectively, data were filtered at 2 and 1 kHz and digitized at 11 and 5 kHz with a Digidata interface controlled by pClamp software (MDS Analytical Technologies, Toronto, Canada). Tail current and voltage sensitivity recordings were digitized at 50 kHz and filtered at 10 kHz. Leak currents were digitally subtracted from corresponding tail currents using Clampfit 9.0 and curves fit using Microcal Origin 6.0 (Northampton, MA). Access resistance and leak currents were monitored continuously, and the recording excluded if either changed significantly. In EPSC experiments sweeps preceded or followed by spontaneous synaptic currents were excluded from analysis. To calculate percent inhibition of EPSC and I_{Ca} amplitudes, the mean peak current from the sweeps collected during the 1 min preceding drug application was compared to the average peak current during the final min of drug treatment, the time at which inhibition was maximal. I_{Ca} elicited at 0.5 Hz underwent significant rundown that was well described by a monoexponential decay function ($r^2=0.99$). Thus, to calculate changes in current amplitude, rundown was determined by fitting an exponential equation to the 3 min preceding drug application; control current amplitude (0 % inhibition) was defined as the value extrapolated to the time at which drug inhibition was calculated.

All data are presented as mean \pm SE. Significance was determined using Student's t test or ANOVA with Bonferroni post test for multiple comparisons.

Results

THC inhibition of EPSCs is modulated by stimulus frequency

The effects of CB1R agonists were studied on excitatory synaptic transmission between rat hippocampal neurons in culture. Synaptic currents were recorded from a postsynaptic cell held at -70 mV in the whole-cell configuration of the patch-clamp. Stimulation of the presynaptic neuron with an extracellular electrode at a rate of 0.1 Hz evoked reproducible EPSCs.

Application of 1 μ M THC inhibited EPSC amplitude by 43 ± 10 % ($n=7$) (Fig. 1A). This level of inhibition by a maximally effective concentration of THC is consistent with the partial agonist properties of THC acting on CB1Rs (Shen and Thayer, 1999). Five minute pretreatment with 300 nM N-(Piperidin-1-yl)-5-(4-iodophenyl)-1-(2,4-dichlorophenyl)-4-methyl-1H-pyrazole-3-carboxamide (AM251), a CB1 antagonist, reduced THC-induced inhibition of EPSC amplitude to 5 ± 4 % ($n=3$, $p<0.01$) consistent with THC acting on CB1 receptors. Interestingly, increasing the stimulation rate to 0.5 Hz reduced the inhibition produced by THC to only 15 ± 2 % ($n=6$), which was significantly different from that seen at the 0.1 Hz stimulus rate (Fig. 1B, $p<0.01$).

Due to the inherent lipophilicity of THC, effective washout from the preparation was not possible and thus THC was irreversible over the time course studied here. We next examined the frequency dependence of EPSC inhibition by the full agonists Win55212-2 (100 nM) and 2-arachidonylglycerol (2-AG) (1 μ M) (Fig. 2). In contrast to THC, Win55212-2 inhibition of EPSC peak amplitude was not different at 0.1 Hz versus 0.5 Hz (Fig. 2A,B) as indicated by a 69 ± 4 % and 58 ± 7 % inhibition of peak current, respectively ($n=6$). The inhibition produced by the eCB agonist 2-AG was also similar at 0.1 and 0.5 Hz, producing 36 ± 9 % and 40 ± 15 % inhibition, respectively ($n=6$). If THC were occupying all of the CB1Rs as would be expected for a maximally effective concentration of a partial agonist, then THC might be expected to antagonize the effects of a full agonist (Kelley and Thayer, 2004; Shen and Thayer, 1999; Straiker and Mackie, 2005). Accordingly, when applied in the continued presence of THC,

Win55212-2 failed to affect EPSC amplitude ($8 \pm 6\%$, $n=6$, $p<0.001$; Fig. 3A,B). Thus, THC blocked the inhibition normally produced by 100 nM Win55212-2 even under conditions in which THC had little effect by itself. These data are consistent with the hypothesis that agonists with low intrinsic activity are particularly sensitive to attenuated presynaptic inhibition by increases in stimulation rate.

THC inhibition of I_{Ca} depends on depolarization rate

Activation of presynaptic CB1Rs inhibits N and P/Q type VGCCs (Lovinger, 2008) resulting in the attenuation of the evoked release of neurotransmitter. Because THC prevented the inhibition of evoked EPSCs by full agonists, we postulated that the reduced inhibition of EPSC amplitude by THC at 0.5 Hz was due to impaired inhibitory coupling to VGCCs. To test this hypothesis we elicited whole-cell I_{Ca} from hippocampal neurons at frequencies of 0.1 and 0.5 Hz. I_{Ca} was evoked from a holding potential of -80 mV by a 40 ms depolarizing step to 0 mV (Fig. 4). 100 nM Win55212-2 inhibited whole-cell I_{Ca} evoked at 0.1 Hz by $51 \pm 6\%$ ($n=5$). Stimulation at 0.5 Hz produced significant Ca^{2+} current rundown that in control recordings was well described by an exponential function ($r^2=0.99$, $n=4$). Thus, to correct for Ca^{2+} current rundown in drug studies, 3 min of baseline preceding addition of drug was fit to a single exponential equation and extrapolated to the time at which drug inhibition was calculated (Fig. 4B,D). 100 nM Win55212-2 inhibited I_{Ca} evoked at 0.5 Hz by $46 \pm 4\%$ ($n=5$) (Fig 4B,E). THC (1 μ M) inhibited whole-cell I_{Ca} elicited at 0.1 Hz by $26 \pm 3\%$ ($n=5$). (Fig. 4C,E). Similar results have been demonstrated in CB1R expressing neurons using common eCBs including 2-AG (Guo and Ikeda, 2004). However, when the currents were evoked at 0.5 Hz THC had no effect ($n=4$) (Fig. 4D,E). Thus, THC inhibition of I_{Ca} was highly sensitive to stimulus frequency ($p<0.01$).

THC inhibition of VGCCs is more sensitive to voltage than inhibition produced by Win55212-2

Previous studies have demonstrated that inhibition of VGCCs by $G\beta\gamma$ is voltage-dependent (Aglar et al., 2003; Bean, 1989; Ikeda, 1996). We hypothesized that inhibition of I_{Ca} by THC would be more easily reversed by depolarization than inhibition mediated by Win55212-2. The voltage-dependent activation of I_{Ca} was determined in the absence (control) or presence of Win55212-2 (100 nM) or THC (1 μ M; Fig 5A-B). Tail currents were recorded at a holding potential of -40 mV after depolarizing test pulses from -40 mV to +70 mV. Activation curves were well described by a single Boltzmann function: $I/I_{max}=1/[1 + \exp\{(V_{0.5}-V_m)/k\}]$. V_m is defined as the activating potential, k is the slope factor and $V_{0.5}$ is the half-maximum activation potential. Under control conditions $V_{0.5}$ was -3 ± 1 mV ($n=6$). Win55212-2 (100 nM) caused a positive shift in the voltage dependence of activation ($V_{0.5} = 8 \pm 1$ mV; $n=3$) while activation kinetics in the presence of THC (1 μ M) were comparable to control ($V_{0.5} = -3 \pm 1$ mV; $n=5$). To determine whether this difference resulted from an increased sensitivity of THC inhibition of I_{Ca} to depolarization relative to that produced by Win55212-2, we studied the effects of depolarizing pre-pulses on drug-induced inhibition of I_{Ca} (Fig 5C-E). A conditioning prepulse to 0 mV facilitated I_{Ca} in the presence of THC, while the facilitation ratio in the presence of Win55212-2 was comparable to that of control (Fig 5C-D). The ratio of the peak amplitude of the first I_{Ca} to the second I_{Ca} (following prepulse) equaled 0.73 ± 0.01 ($n=27$) under control conditions, 0.75 ± 0.03 in the presence of Win55212-2 (100 nM; $n=12$) and 0.81 ± 0.02 in the presence of THC (1 μ M; $n=6$). A conditioning prepulse to +80 mV relieved both THC and Win55212-2-mediated suppression of I_{Ca} (Fig 5C-D). The facilitation ratio for control experiments equaled 1.11 ± 0.03 ($n=35$) versus 1.67 ± 0.08 in the presence of Win55212-2 (100 nM; $n=12$) and 1.35 ± 0.10 in the presence of THC (1 μ M; $n=6$). A second protocol using paired depolarizations to 0 mV verified that THC-induced inhibition of I_{Ca} is more sensitive to mild depolarization than Win55212-2 (Fig

5E). The facilitation ratio for control (n=41) and Win55212-2 (100nM, n=12) treated currents were 0.83 ± 0.01 and 0.83 ± 0.02 , respectively and the ratio for THC (1 μ M; n=10) was 0.96 ± 0.02 . Thus, THC mediated inhibition of I_{Ca} is more sensitive to positive shifts in membrane potential than inhibition produced by Win55212-2.

THC inhibits DSE

The frequency dependence of THC-induced inhibition of I_{Ca} and EPSCs suggests that THC may act as an agonist or antagonist depending on the firing rate of the synapse. This frequency dependent shift in efficacy could have profound effects on eCB signaling. To examine the effects of THC on CB1R activation by the retrograde actions of eCBs we employed the depolarization-induced suppression of excitation (DSE) protocol previously described for hippocampal neurons in culture (Ohno-Shosaku et al., 2002; Straiker and Mackie, 2005). In these experiments, EPSCs were evoked at 0.5 Hz and endocannabinoid production was induced by depolarizing the postsynaptic neuron to 0 mV for 15 s. Immediately following depolarization, a transient DSE (DSE 1) lasting 60 to 90 s was observed with inhibition of EPSCs reaching 46 ± 8 % (Fig. 6A,D; n=8). Following 5 min of continued stimulation (0.5 Hz) a second depolarization to 0 mV was applied (DSE 2) (Fig. 6B,D). Under control conditions DSE2 produced a 47 ± 10 % inhibition of EPSC amplitude (n=4), similar to DSE1. DSE was completely blocked by pretreatment (5 min) with 300 nM AM251 (data not shown). Similar to the actions of the antagonist, in synaptic pairs treated for 5 min with 1 μ M THC, DSE2 was completely blocked (6 ± 6 %; n=4) (Fig. 6C,D). THC significantly reduced DSE relative to control ($p < 0.001$).

Discussion

The effects of THC on synaptic networks are complex and not fully explained by agonist actions. In the current study, we show that the effects of THC on glutamatergic synapses between hippocampal neurons switch between agonist and antagonist actions on CB1Rs, depending on stimulus rate. When EPSCs were evoked at 0.1 Hz, THC acted as a weak agonist of CB1Rs to inhibit synaptic transmission. In contrast, when stimulated at 0.5 Hz, THC had little direct effect and actually acted as an antagonist capable of blocking the actions of exogenously applied and endogenously produced cannabinoids. Voltage-sensitive coupling of CB1Rs to VGCCs caused these state-dependent actions of THC. The extreme sensitivity of the actions of THC to firing frequency was not previously appreciated and the concept that agonists of low intrinsic activity might act as antagonists during certain patterns of activity has broad implications for the many drugs that act on presynaptic GPCRs to inhibit neurotransmitter release.

Frequency-dependent coupling of CB1Rs to presynaptic VGCCs

Activation of CB1Rs inhibits EPSCs and sensitive IPSCs between hippocampal neurons (Hajos et al., 2000; Shen et al., 1996). Generally, presynaptic inhibition mediated by GPCRs can be overcome by increases in firing rate (Brenowitz et al., 1998; Frerking and Ohliger-Frerking, 2006). Indeed, increasing the presynaptic firing rate to >20 Hz reversed Win55212-2 inhibition of inhibitory postsynaptic currents (IPSCs) (Foldy et al., 2006). In the current study, inhibition of EPSCs by THC was completely blocked by a modest increase in presynaptic stimulus rate to 0.5 Hz. Thus, the inhibition mediated by THC is some 40 times more sensitive to firing rate than that mediated by full CB1R agonists. We speculate that the high sensitivity of THC-mediated inhibition of synaptic transmission to firing frequency contributes to the variable effects reported for this drug in in vitro models. The only experiments to describe THC-mediated inhibition of synaptic transmission were performed at a stimulus rate of 0.1 Hz or less (Azad et al., 2008; Pertwee et al., 1996; Shen and Thayer, 1999) or employed intermittent burst-type stimulus protocols with prolonged inter stimulus intervals (Pertwee et al., 1992). Interestingly, a partial

agonist at 5HT₃ receptors was previously shown to display a frequency-dependent reduction in the efficacy for inhibition of neurotransmitter release (Van der Vliet et al., 1988), suggesting that a general property of presynaptic inhibition produced by agonists of low intrinsic activity may be an especially high sensitivity to firing rate.

The short-term effects of cannabinoid agonists on synaptic transmission are primarily mediated by inhibition of presynaptic VGCCs (Lovinger, 2008). Because the relationship of presynaptic $[Ca^{2+}]_i$ to vesicular release is a power function, small changes in Ca^{2+} influx have large effects on neurotransmission. CB1Rs couple to VGCCs via the $\beta\gamma$ subunits of inhibitory G-proteins (Agler et al., 2003). We found that increased firing rate reduced THC inhibition of whole-cell I_{Ca} through VGCCs. Frequency dependent relief of VGCC channel inhibition has been attributed to the accumulation of residual Ca^{2+} in the presynaptic terminal at high frequencies (Kreitzer and Regehr, 2000) and might contribute to the frequency dependence of THC inhibition of EPSCs but, would not account for the frequency-dependent modulation of VGCCs. The most likely explanation for the reduction in CB1R coupling to VGCCs is the relief of G-protein-mediated inhibition that occurs during repetitive physiological stimuli (Brody et al., 1997). This attenuation of GPCR-mediated inhibition of VGCCs results from voltage-dependent reversal of $G\beta\gamma$ coupling to N and P/Q type Ca^{2+} channels (Agler et al., 2003; Bean, 1989; Ikeda, 1996). We observed a positive shift in the activation curve for I_{Ca} in the presence of Win55212-2, consistent with a voltage-sensitive coupling between CB1R and VGCC. In the presence of THC I_{Ca} was facilitated by a small depolarizing prepulse, indicating that THC inhibition of VGCC was even more sensitive to voltage than that produced by Win55212-2. Thus, the inefficient release of $\beta\gamma$ subunits evoked by THC (Breivogel and Childers, 2000) relative to full agonists, appears to make THC-mediated synaptic inhibition extremely sensitive to voltage.

THC and the endocannabinoid system

If the attenuation of THC-mediated synaptic inhibition results from a frequency dependent reduction in $\beta\gamma$ coupling to VGCCs, then the binding of THC to CB1Rs would not necessarily be affected by stimulus rate. Indeed, at the high (0.5 Hz) stimulus rate THC clearly occupied the receptor, even though it failed to affect synaptic transmission, as indicated by block of Win55212-2-mediated inhibition of EPSC amplitude. This observation has significant implications for how THC interacts with the eCB system. We found that THC acted as an antagonist in DSE experiments, presumably because the DSE protocol requires fast stimulus rates in order to resolve the inhibition of EPSCs produced by the transient production of eCBs. Our results agree with those of Straiker and Mackie (2005) in that THC antagonized the eCB system. However, they did not observe an effect of THC at low stimulus frequency, presumably the combination of low receptor density and low agonist efficacy prevents effective CB1R coupling to VGCC. Chronic exposure to THC desensitized CB1Rs, consistent with studies that found prolonged treatment with THC in vivo produced a functional desensitization that impaired synaptic plasticity and prevented Win55212-2 mediated inhibition of IPSCs (Hoffman et al., 2007; Mato et al., 2004). The desensitization of CB1Rs, mediated by $\beta\gamma$ activation of G-protein receptor kinases (Jin et al., 1999; Kouznetsova et al., 2002), would not be expected to display the frequency (voltage) dependence described for coupling to VGCCs.

In contrast to presynaptic inhibition mediated by autoreceptors that respond to released neurotransmitter, THC modulates a receptor in which the endogenous ligand is distinct from that which mediates synaptic transmission. Thus, we envision at least four states under which THC will exert different effects on synaptic transmission. At low firing frequencies THC will mimic the actions of eCBs to inhibit synaptic transmission. If eCBs are present their actions would be occluded. In contrast, at high firing rates THC will have little direct effect. When eCB

production is stimulated and the synapse is firing at a high frequency, THC will block the actions of eCBs.

THC affects firing patterns and behavior

The inhibition of low frequency EPSCs by THC (as shown in Fig. 1A) is predicted to remove the slow component of a complex firing pattern. The idea that the frequency-dependence of drug-induced presynaptic inhibition applies a high-pass filter to affected synapses has been previously suggested (Frerking and Ohliger-Frerking, 2006). For example, baclofen (a GABA_B receptor agonist) acted to enhance the contrast between low and high frequency field excitatory postsynaptic potentials during application of physiological spike trains taken from animals in a delayed non-matched to sample behavioral paradigm. The drug preferentially inhibited field excitatory postsynaptic potentials that followed long inter spike intervals (ISI) at CA3 to CA1 synapses. The average firing rate of CA3 neurons was near 1 Hz and the change in ISI near 0.1 Hz, close to the frequencies over which THC displayed dramatic changes in efficacy in the current study. Interestingly, cells exhibiting longer ISIs (near 0.1 Hz) tended to fire in response to specific cues and were inhibited by baclofen, while neurons that integrated multiple inputs had shorter ISIs (near 1 Hz) and were less sensitive to baclofen. Our data suggest that THC might also enhance the importance of high frequency integrative inputs relative to more specific low frequency inputs.

THC has broad actions in the CNS, most of which are reversed by CB1R antagonists (Chaperon and Thiebot, 1999; Rinaldi-Carmona et al., 1994). However, some behavioral responses to THC suggest actions more complex than simple agonist effects. THC suppresses certain operant behaviors in a manner not effectively reversed by rimonabant, a CB1R antagonist (De Vry and Jentsch, 2004; McMahon et al., 2005). The eCB system also participates in complex hippocampal functions including memory extinction (Zhuang et al., 2005). THC retarded extinction of an adverse associative memory (Ashton et al., 2008) in

contrast to acceleration induced by Win55212-2 (Pamplona et al., 2006) and similar to the slowed extinction found in CB1R knockout animals (Marsicano et al., 2002). A human study found THC actually enhanced a spatial working memory task for females and increased intrusion errors in spatial span tasks in both males and females (Makela et al., 2006). THC antagonism of eCB mediated plasticity might underlie these effects, although linking synaptic transmission experiments to behavior is highly speculative.

Conclusions

We have shown that the effects of THC on neurotransmission depend on the firing rate of the synapse and the presence of eCBs. Because the actions of THC are more sensitive to firing rate than highly efficacious cannabinoid agonists such as Win55212-2, we caution that results obtained in vitro with full agonists may not accurately reflect the more complex actions of THC in vivo. Going forward, it will be important to resolve the electrophysiological and behavioral consequences for presynaptic inhibition produced by agonists of differing intrinsic activities.

Footnotes

This work was supported by National Institutes of Health grants DA07304 and DA11806 from the National Institute on Drug Abuse and by National Science Foundation grant IOS0814549.

A.R. was supported by NIDA training grant DA07097.

Reprints

Stanley A. Thayer, Department of Pharmacology, University of Minnesota, 6-120 Jackson Hall,
321 Church Street, Minneapolis, MN 55455, USA

Tel.: +1-612-626-7049; Fax: +1-612-625-8408; E-mail: sathayer@umn.edu

References

- Agler HL, Evans J, Colecraft HM and Yue DT (2003) Custom Distinctions in the Interaction of G-protein β Subunits with N-type (CaV2.2) Versus P/Q-type (CaV2.1) Calcium Channels. *J Gen Physiol* **121**:495-510.
- Ashton JC, Smith PF and Darlington CL (2008) The effect of delta 9-tetrahydrocannabinol on the extinction of an adverse associative memory. *Pharmacology* **81**:18-20.
- Azad SC, Kurz J, Marsicano G, Lutz B, Zieglgansberger W and Rammes G (2008) Activation of CB1 specifically located on GABAergic interneurons inhibits LTD in the lateral amygdala. *Learn Mem* **15**:143-152.
- Bean BP (1989) Neurotransmitter inhibition on neuronal calcium currents by changes in channel voltage dependence. **340**:153-156.
- Breivogel CS and Childers SR (2000) Cannabinoid Agonist Signal Transduction in Rat Brain: Comparison of Cannabinoid Agonists in Receptor Binding, G-Protein Activation, and Adenylyl Cyclase Inhibition. *J Pharmacol Exp Ther* **295**:328-336.
- Brenowitz S, David J and Trussell L (1998) Enhancement of Synaptic Efficacy by Presynaptic GABAB Receptors. *Neuron* **20**:135-141.
- Brody DL, Patil PG, Mulle JG, Snutch TP and Yue DT (1997) Bursts of action potential waveforms relieve G-protein inhibition of recombinant P/Q-type Ca²⁺ channels in HEK 293 cells. *J Physiol* **499**:637-644.
- Brown SP, Safo PK and Regehr WG (2004) Endocannabinoids Inhibit Transmission at Granule Cell to Purkinje Cell Synapses by Modulating Three Types of Presynaptic Calcium Channels. *J Neurosci* **24**:5623-5631.
- Chaperon F and Thiebot MH (1999) Behavioral effects of cannabinoid agents in animals. *Crit Rev Neurobiol* **13**:243-281.

- De Vry J and Jentsch KR (2004) Partial agonist-like profile of the cannabinoid receptor antagonist SR141716A in a food-reinforced operant paradigm. *Behav Pharmacol* **15**:13-20.
- Eissenstat MA, Bell MR, D'Ambra TE, Estep KG, Haycock DA, Olefirowicz EM and Ward SJ (1990) Aminoalkylindoles (AAIs): structurally novel cannabinoid-mimetics. *NIDA research monograph* **105**:427-428.
- Foldy C, Neu A, Jones MV and Soltesz I (2006) Presynaptic, Activity-Dependent Modulation of Cannabinoid Type 1 Receptor-Mediated Inhibition of GABA Release. *J Neurosci* **26**:1465-1469.
- Frerking M and Ohliger-Frerking P (2006) Functional Consequences of Presynaptic Inhibition During Behaviorally Relevant Activity. *J Neurophysiol* **96**:2139-2143.
- Guo J and Ikeda SR (2004) Endocannabinoids modulate N-type calcium channels and G-protein-coupled inwardly rectifying potassium channels via CB1 cannabinoid receptors heterologously expressed in mammalian neurons. *Mol Pharmacol* **65**:665-674.
- Hajos N, Katona I, Naiem SS, Mackie K, Ledent C, Mody I and Freund TF (2000) Cannabinoids inhibit hippocampal GABAergic transmission and network oscillations. *Eur J Neurosci* **12**:3239-3249.
- Hoffman AF, Oz M, Yang R, Lichtman AH and Lupica CR (2007) Opposing actions of chronic Δ^9 -tetrahydrocannabinol and cannabinoid antagonists on hippocampal long-term potentiation. *Learn Mem.*
- Howlett AC (2005) Cannabinoid receptor signaling. *Handb Exp Pharmacol*(168):53-79.
- Ikeda SR (1996) Voltage-dependent modulation of N-type calcium channels by G-protein beta-gamma subunits. *Nature* **380**:255-258.
- Jin W, Brown S, Roche JP, Hsieh C, Celver JP, Koovor A, Chavkin C and Mackie K (1999) Distinct domains of the CB1 cannabinoid receptor mediate desensitization and internalization. *J Neurosci* **19**:3773-3780.

- Kelley BG and Thayer SA (2004) Delta 9-tetrahydrocannabinol antagonizes endocannabinoid modulation of synaptic transmission between hippocampal neurons in culture. *Neuropharmacol* **46**:709-715.
- Kouznetsova M, Kelley B, Shen M and Thayer SA (2002) Desensitization of cannabinoid-mediated presynaptic inhibition of neurotransmission between rat hippocampal neurons in culture. *Mol Pharmacol* **61**:477-485.
- Kreitzer AC and Regehr WG (2000) Modulation of transmission during trains at a cerebellar synapse. *J Neurosci* **20**:1348-1357.
- Lovinger DM (2008) Presynaptic modulation by endocannabinoids. *Handb Exp Pharmacol* **184**:435-477.
- Lundberg DJ, Daniel AR and Thayer SA (2005) D⁹-Tetrahydrocannabinol-induced desensitization of cannabinoid-mediated inhibition of synaptic transmission between hippocampal neurons in culture. *Neuropharmacol* **49**:1170-1177.
- Makela P, Wakeley J, Gijsman H, Robson PJ, Bhagwagar Z and Rogers RD (2006) Low doses of delta-9 tetrahydrocannabinol (THC) have divergent effects on short-term spatial memory in young, healthy adults. *Neuropsychopharmacol* **31**:462-470.
- Marsicano G, Wotjak CT, Azad SC, Bisogno T, Rammes G, Cascio MG, Hermann H, Tang J, Hofmann C, Zieglgansberger W, Di Marzo V and Lutz B (2002) The endogenous cannabinoid system controls extinction of aversive memories. *Nature* **418**:530-534.
- Mato S, Chevalere V, Robbe D, Pazos A, Castillo PE and Manzoni OJ (2004) A single in-vivo exposure to Delta 9THC blocks endocannabinoid-mediated synaptic plasticity. *Nature Neurosci* **7**:585-586.
- McMahon LR, Amin MR and France CP (2005) SR 141716A differentially attenuates the behavioral effects of delta9-THC in rhesus monkeys. *Behav Pharmacol* **16**:363-372.

Ohno-Shosaku T, Tsubokawa H, Mizushima I, Yoneda N, Zimmer A and Kano M (2002)

Presynaptic Cannabinoid Sensitivity Is a Major Determinant of Depolarization-Induced Retrograde Suppression at Hippocampal Synapses. *J Neurosci* **22**:3864-3872.

Pamplona FA, Prediger RD, Pandolfo P and Takahashi RN (2006) The cannabinoid receptor agonist WIN 55,212-2 facilitates the extinction of contextual fear memory and spatial memory in rats. *Psychopharmacology (Berl)* **188**:641-649.

Pertwee RG, Fernando SR, Nash JE and Coutts AA (1996) Further evidence for the presence of cannabinoid CB1 receptors in guinea-pig small intestine. *Br J Pharmacol* **118**:2199-2205.

Pertwee RG, Stevenson LA, Elrick DB, Mechoulam R and Corbett AD (1992) Inhibitory effects of certain enantiomeric cannabinoids in the mouse vas deferens and the myenteric plexus preparation of guinea-pig small intestine. *Br J Pharmacol* **105**:980-984.

Pottorf WJ, Johanns TM, Derrington SM, Strehler EE, Enyedi A and Thayer SA (2006) Glutamate-induced protease-mediated loss of plasma membrane Ca pump activity in rat hippocampal neurons. *J Neurochem* **98**:1646-1656.

Rinaldi-Carmona M, Barth F, Heaulme M, Shire D, Calandra B, Congy C, Martinez S, Maruani J, Neliat G, Caput D and et al. (1994) SR141716A, a potent and selective antagonist of the brain cannabinoid receptor. *FEBS Lett* **350**:240-244.

Selley DE, Rorrer WK, Breivogel CS, Zimmer AM, Zimmer A, Martin BR and Sim-Selley LJ (2001) Agonist efficacy and receptor efficiency in heterozygous CB1 knockout mice: relationship of reduced CB1 receptor density to G-protein activation. *J Neurochem* **77**:1048-1057.

Shen M, Piser TM, Seybold VS and Thayer SA (1996) Cannabinoid receptor agonists inhibit glutamatergic synaptic transmission in rat hippocampal cultures. *J Neurosci* **16**:4322-4334.

Shen M and Thayer SA (1999) Δ^9 -tetrahydrocannabinol acts as a partial agonist to modulate glutamatergic synaptic transmission between rat hippocampal neurons in culture. *Mol Pharmacol* **55**:8-13.

Straiker A and Mackie K (2005) Depolarization-induced suppression of excitation in murine autaptic hippocampal neurones. *J Physiol* **569**:501-517.

Van der Vliet A, Van der Werf JF, Bast A and Timmerman H (1988) Frequency-dependent autoinhibition of histamine release from rat cortical slices: a possible role for H3 receptor reserve. *The Journal of pharmacy and pharmacology* **40**:577-579.

Zhuang S, Hampson RE and Deadwyler SA (2005) Behaviorally relevant endocannabinoid action in hippocampus: dependence on temporal summation of multiple inputs. *Behav Pharmacol* **16**:463-471.

Figure Legends

Figure 1. Increased stimulus rate blocks THC inhibition of EPSC amplitude. A bipolar concentric electrode placed near a presynaptic neuron was used to evoke EPSCs in a postsynaptic cell held at -70 mV in whole-cell voltage-clamp. Representative plots show peak EPSC amplitude versus time. EPSCs were evoked every 10 s (0.1 Hz) (A) or every 2 s (0.5 Hz) (B). 1 μ M THC was applied during the time indicated by the black horizontal bars. Gray bars indicate the time and amplitude of the corresponding averaged EPSCs displayed in the insets, denoted as (a) or (b). Insets, vertical bar represents 100 pA and horizontal bar represents 20 ms.

Figure 2. Win55212-2 and 2-arachidonylglycerol inhibit EPSC amplitude similarly at 0.1 and 0.5 Hz stimulus rates. Representative plots show peak EPSC amplitude versus time. EPSCs were evoked every 10 s (0.1 Hz) (A, C) or every 2 s (0.5 Hz) (B, D). Win55212-2 (Win-2) and 2-arachidonylglycerol (2-AG) were applied during the times indicated by the black horizontal bars. Gray bars indicate the time and amplitude of the corresponding averaged EPSCs displayed in the insets, denoted as (a), (b), or (c). Insets, vertical bar represents 100 pA and horizontal bar represents 20 ms.

Figure 3. THC antagonizes Win55212-2 inhibition of EPSCs evoked at 0.5 Hz. (A) Representative plot shows peak EPSC amplitude versus time. 1 μ M THC and 100 nM Win55212-2 (Win-2) were applied during the times indicated by the black horizontal bars. Gray bars indicate the time and amplitude of the corresponding averaged EPSCs displayed in the inset, denoted as (a), (b), or (c). Inset, vertical bar represents 100 pA and horizontal bar represents 20 ms. (B) Bar graph shows percent inhibition of EPSCs evoked at 0.1 (open bars) or 0.5 Hz (solid bars) treated with 100 nM Win55212-2 (Win-2), 1 μ M 2-arachidonylglycerol (2-

AG), 1 μ M THC or 300 nM AM251 as indicated. **, $p < 0.01$, 0.1 Hz versus 0.5 Hz; ††, $p < 0.01$, compared to THC at 0.1 Hz; ###, $p < 0.001$, compared to Win-2 at 0.5 Hz.

Figure 4. THC inhibition of VGCC is dependent on stimulus rate. A-D, representative plots show peak I_{Ca} versus time. I_{Ca} were evoked by a depolarizing step from -80 mV to 0 mV for 40 ms at either 0.1 Hz (A,C) or 0.5 Hz (B,D). 100 nM Win55212-2 (Win-2) or 1 μ M THC were applied during the times indicated by the black horizontal bars. For recordings in which the depolarizing stimulus was applied at 0.5 Hz (B, D) current rundown was determined by fitting an exponential equation to the 3 min preceding drug application; control current amplitude (0 % inhibition) was defined as the value extrapolated to the time at which drug inhibition was calculated. Insets show the mean current trace from the sweeps collected during the 1 min preceding drug application superimposed on the averaged current traces during the final min of drug treatment. Inset, vertical bars represent 500 pA and horizontal bars represent 20 ms. The small horizontal lines in the insets to B and D represent the extrapolated curve fit during drug treatment. (E) Bar graph shows inhibition of I_{Ca} evoked at 0.1 Hz (open bars) or 0.5 Hz (solid bars) by Win55212-2 (Win-2) and THC. **, $p < 0.01$ THC effects at 0.1 versus 0.5 Hz.

Figure 5. THC inhibition of I_{Ca} is more sensitive to voltage than inhibition by Win55212-2. (A) Plots display I_{Ca} activation curves in the absence (control; ■) or presence of 1 μ M THC (●) or 100 nM Win55212-2 (Win-2; ▲). Voltage protocol is displayed in inset. Normalized tail current amplitudes are plotted versus the voltage of a test prepulse and the solid lines describe curves fit to the data with a single Boltzmann function: $I/I_{max} = 1/[1 + \exp\{(V_{0.5} - V_m)/k\}]$. Calculated values for $V_{0.5}$ and k were respectively, -3 mV and 10 mV for control, -3 mV and 10 mV in THC, and 8 mV and 17 mV in Win55212-2. (B) Representative tail currents evoked from +10 mV and +70 mV prepulses are overlaid. Vertical bars represent 1 nA and horizontal bars represent 1 ms. (C) Representative I_{Ca} resulting from prepulse voltage protocol (top). A prepulse to 0 mV

facilitated I_{Ca} in the presence of THC. A prepulse to +80 mV facilitated I_{Ca} in the presence of both THC and Win-2. Vertical bars represent 200 pA and horizontal bars represent 20 ms. (D) Bar graphs summarizes facilitation of I_{Ca} by a prepulse to either 0 mV or +80 mV as described in C. *, $p < 0.05$ THC versus control at 0 mV; ***, $p < 0.001$ Win-2 versus control at +80 mV; †, $p < 0.05$ THC versus control at +80 mV. (E) Bar graph displays the ratio of I_{Ca} amplitudes evoked by paired depolarizations to 0 mV. Representative traces show currents for each respective condition. Vertical bars represent 200 pA and horizontal bars represent 10 ms. ***, $p < 0.001$ THC versus control; †††, $p < 0.001$. THC versus Win-2.

Figure 6. Inhibition of DSE by THC. A-C, EPSCs were evoked at 0.5 Hz. Plots show mean EPSC amplitudes, normalized to the 15 responses immediately before depolarization, plotted versus time. The postsynaptic cell was depolarized to 0 mV for 15 s at the times indicated by arrows. A, an initial control DSE (DSE1) was elicited in each recording. A second postsynaptic depolarization (DSE2) was evoked after 5 min treatment with vehicle (B) or 1 μ M THC (C). D, bar graph shows the mean magnitude of DSE1 and DSE2 in the absence (open bars) and presence of 1 μ M THC (solid bar). Percent DSE was calculated according to the following equation, % DSE = $100(\text{EPSC}_{\text{control}} - \text{EPSC}_{\text{DSE}}) / \text{EPSC}_{\text{control}}$ where $\text{EPSC}_{\text{control}}$ is the average amplitude of the 15 EPSCs immediately prior to depolarization and EPSC_{DSE} is the average amplitude of the two EPSCs immediately after depolarization. ***, $p < 0.001$ DSE2 in absence relative to in the presence of THC.

Fig 1

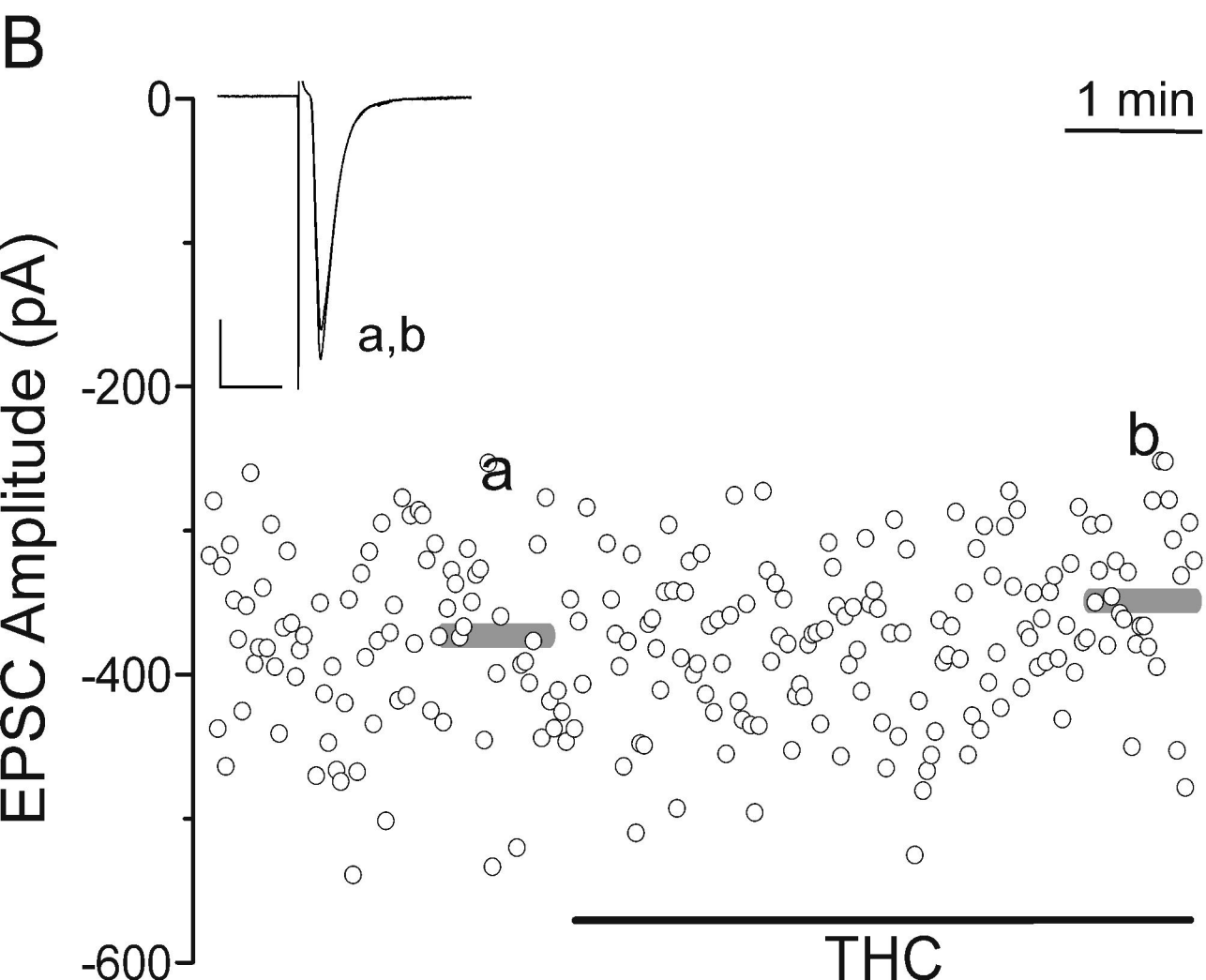
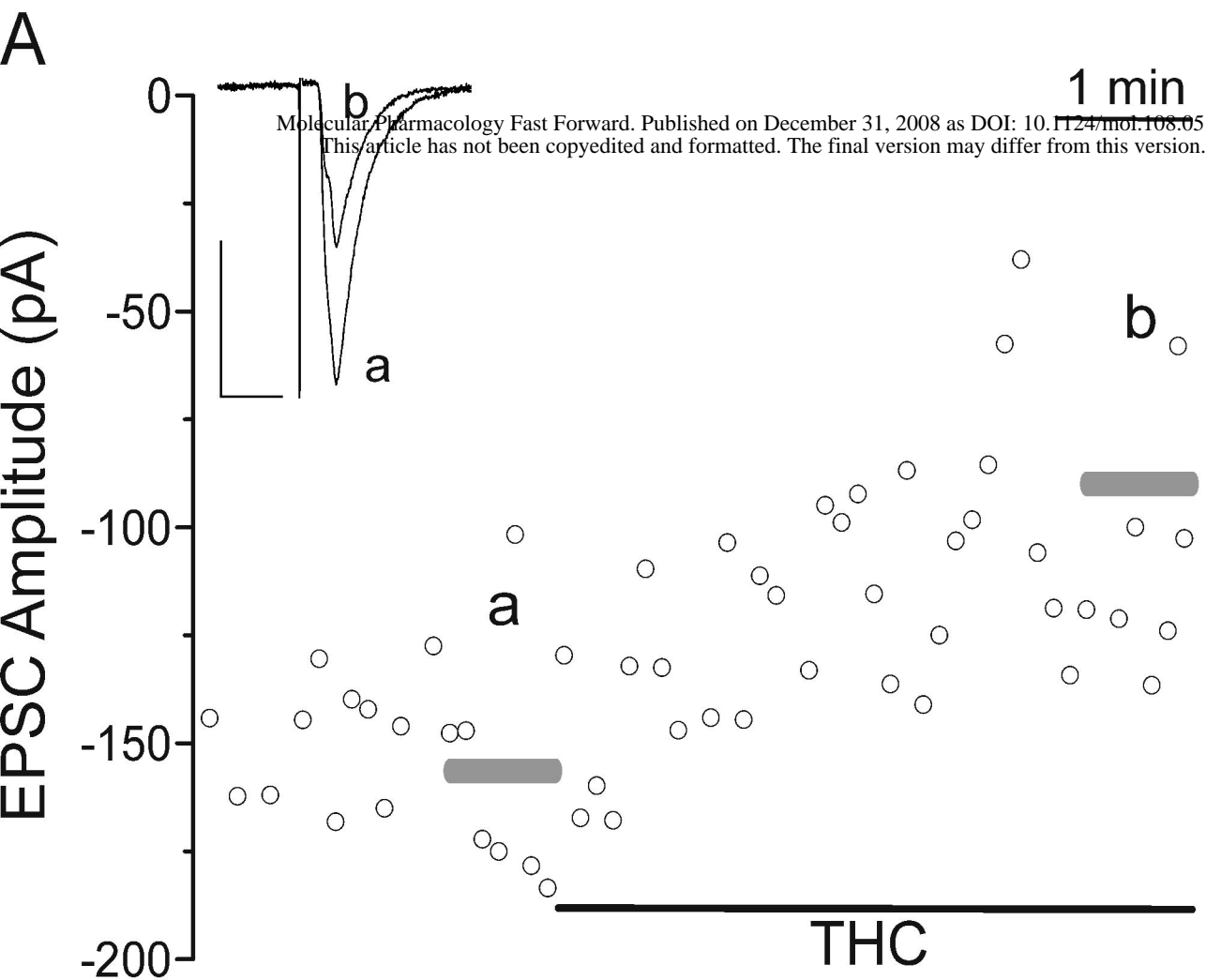

Fig 2

Fig 3

A



B

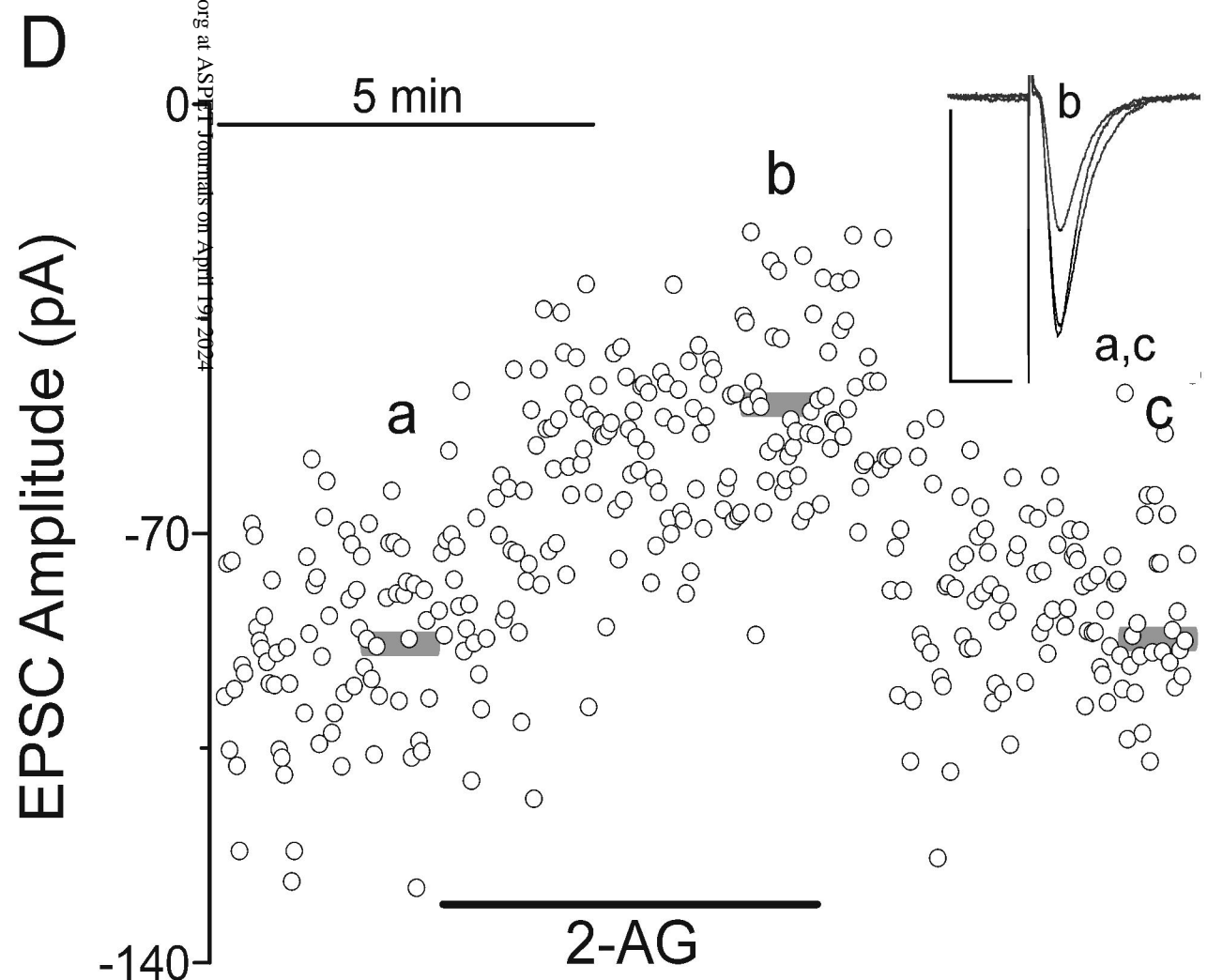
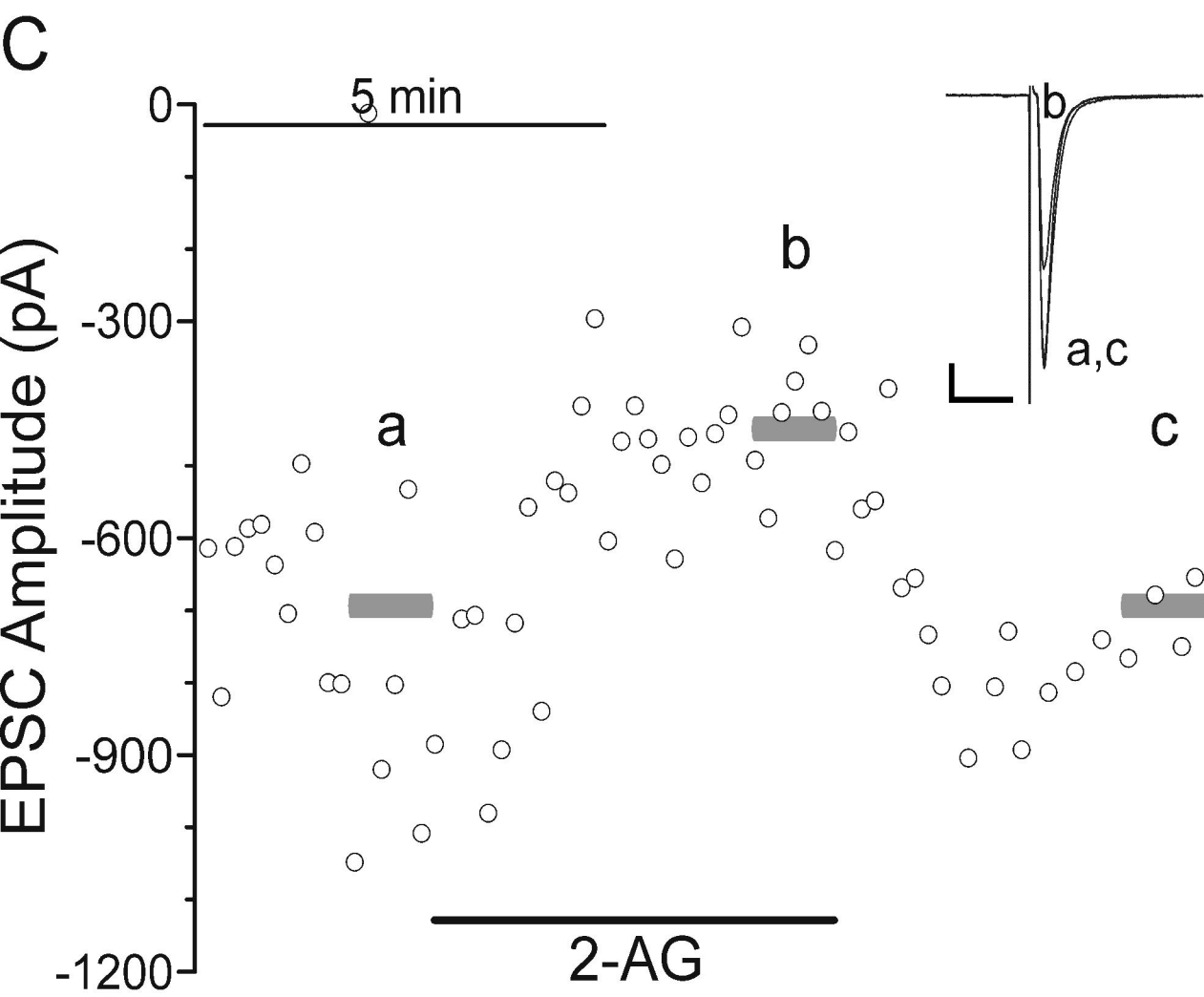
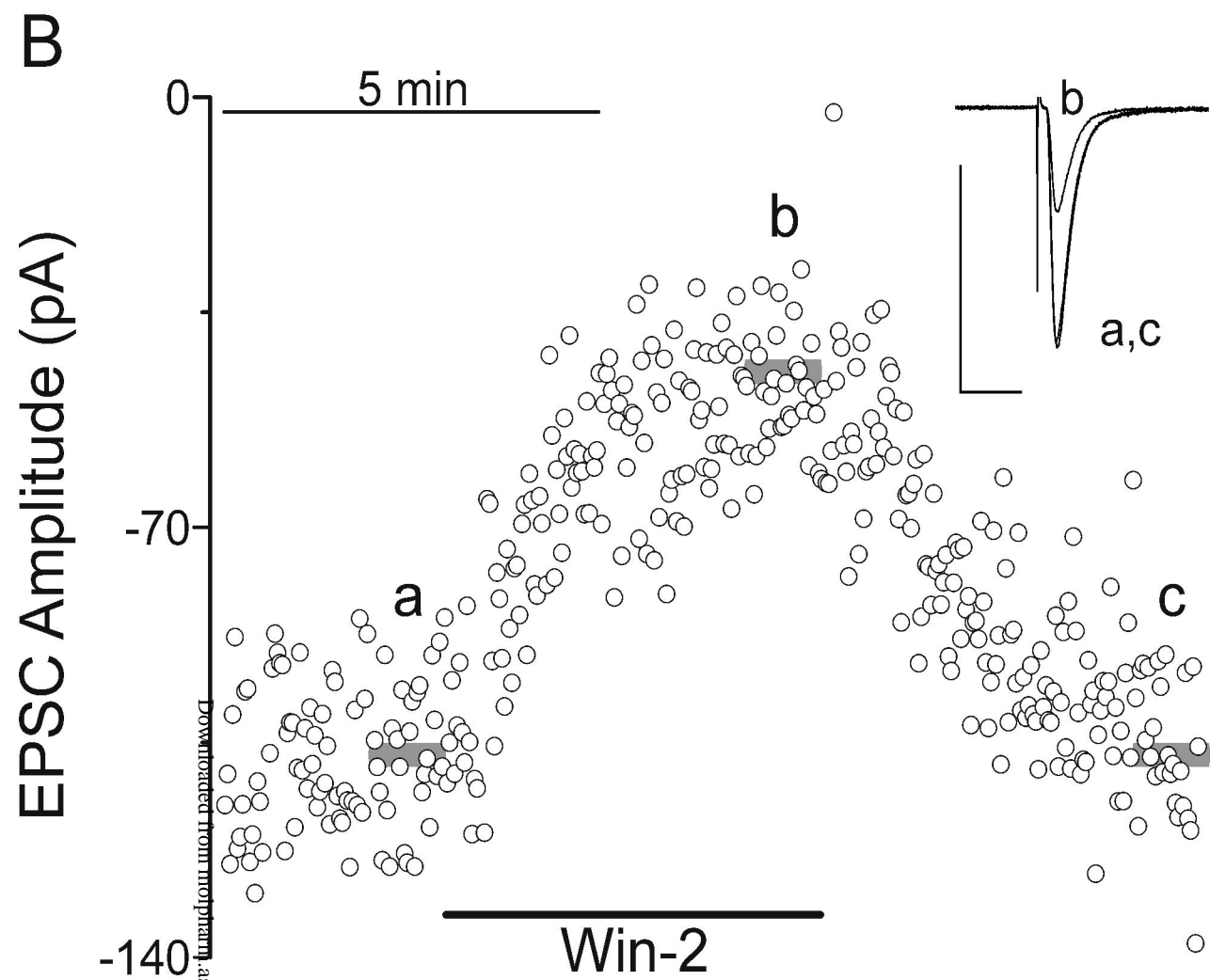
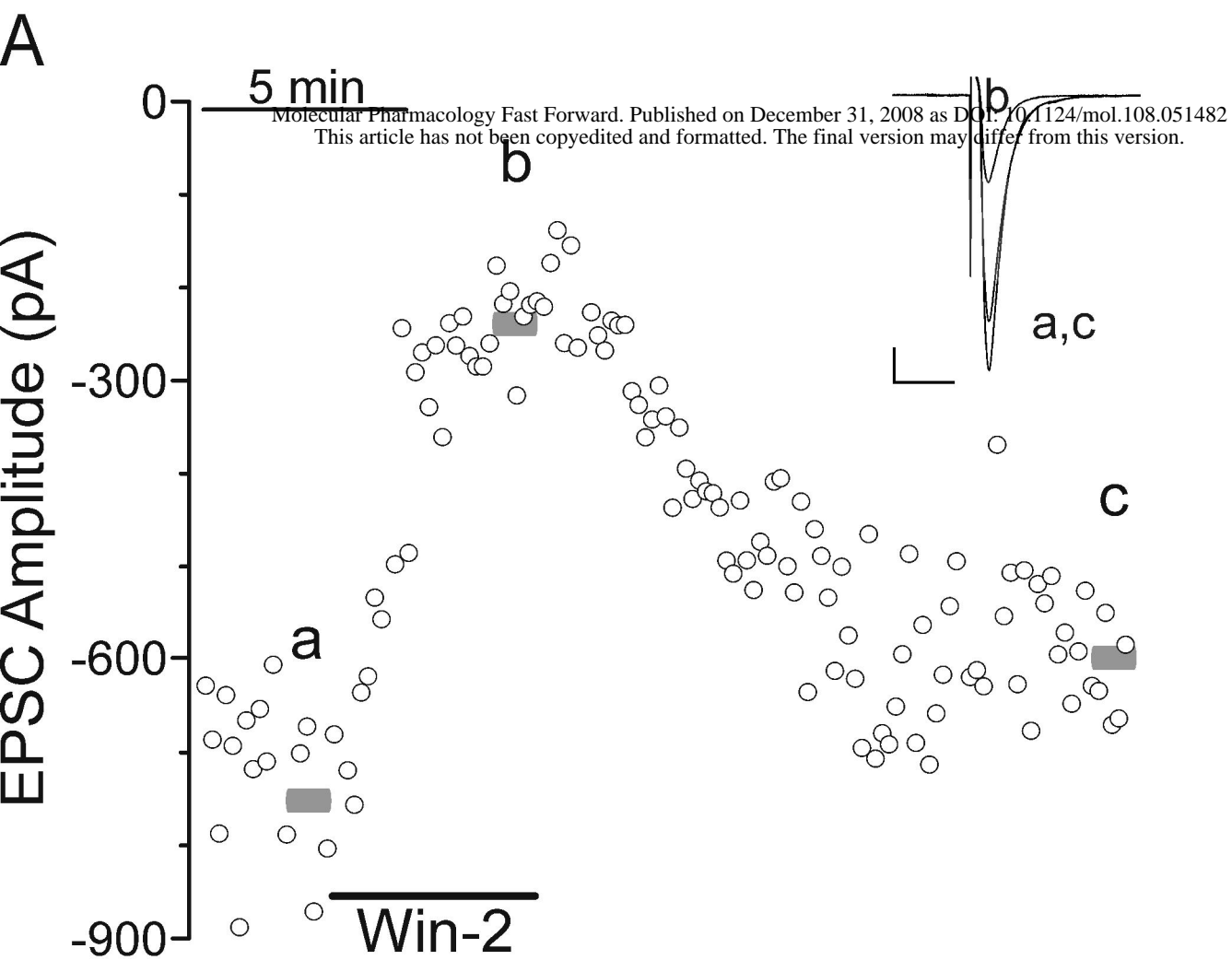
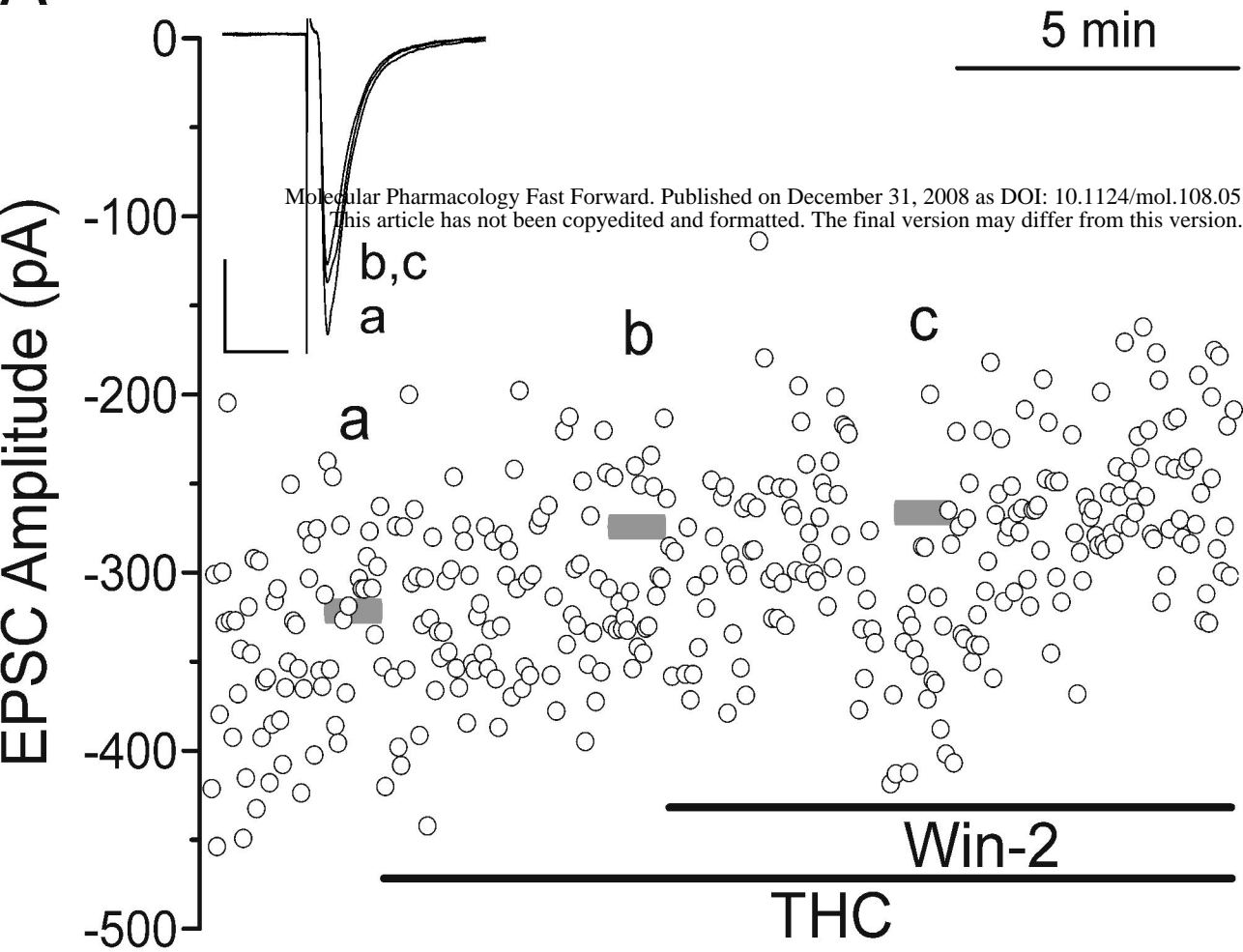
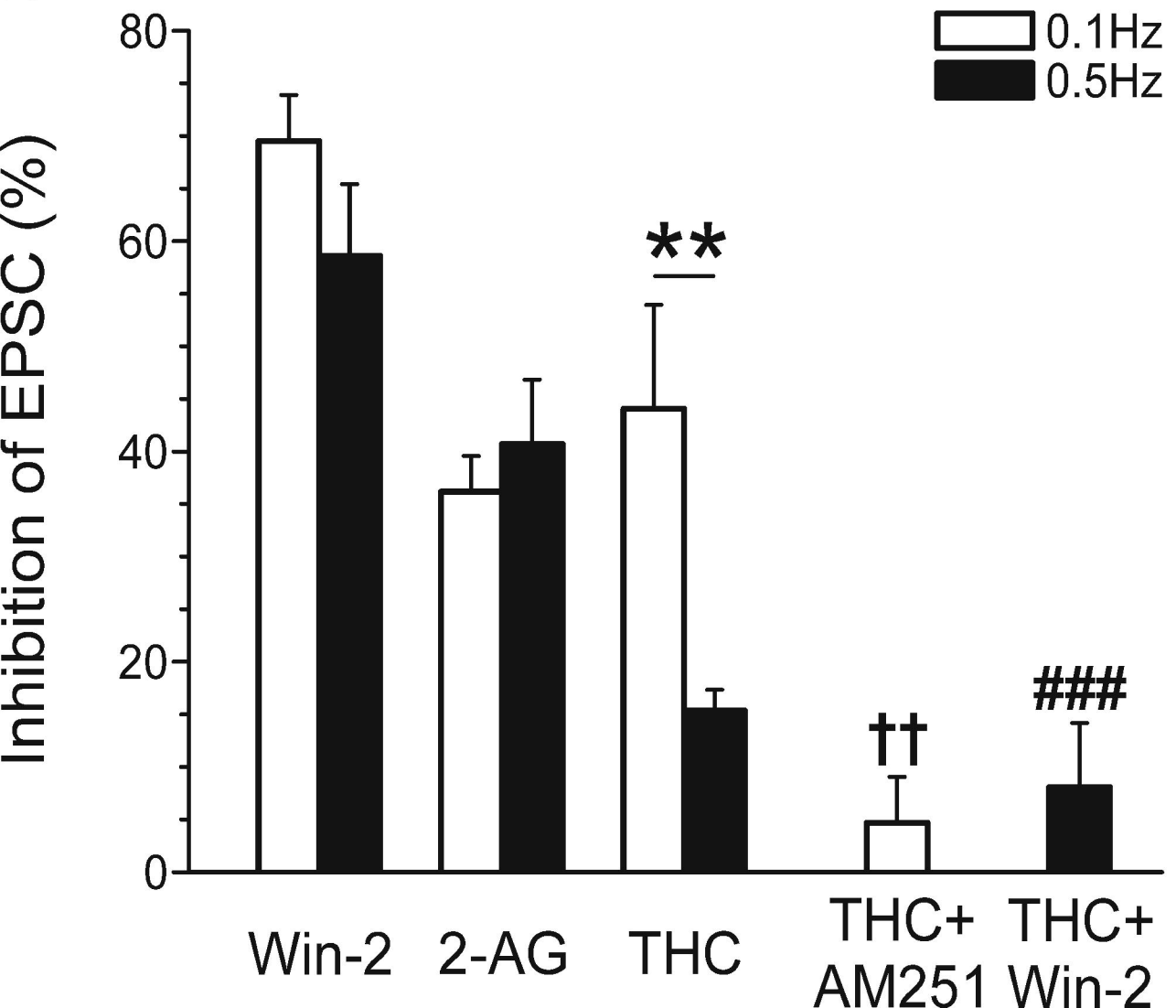

Fig 4

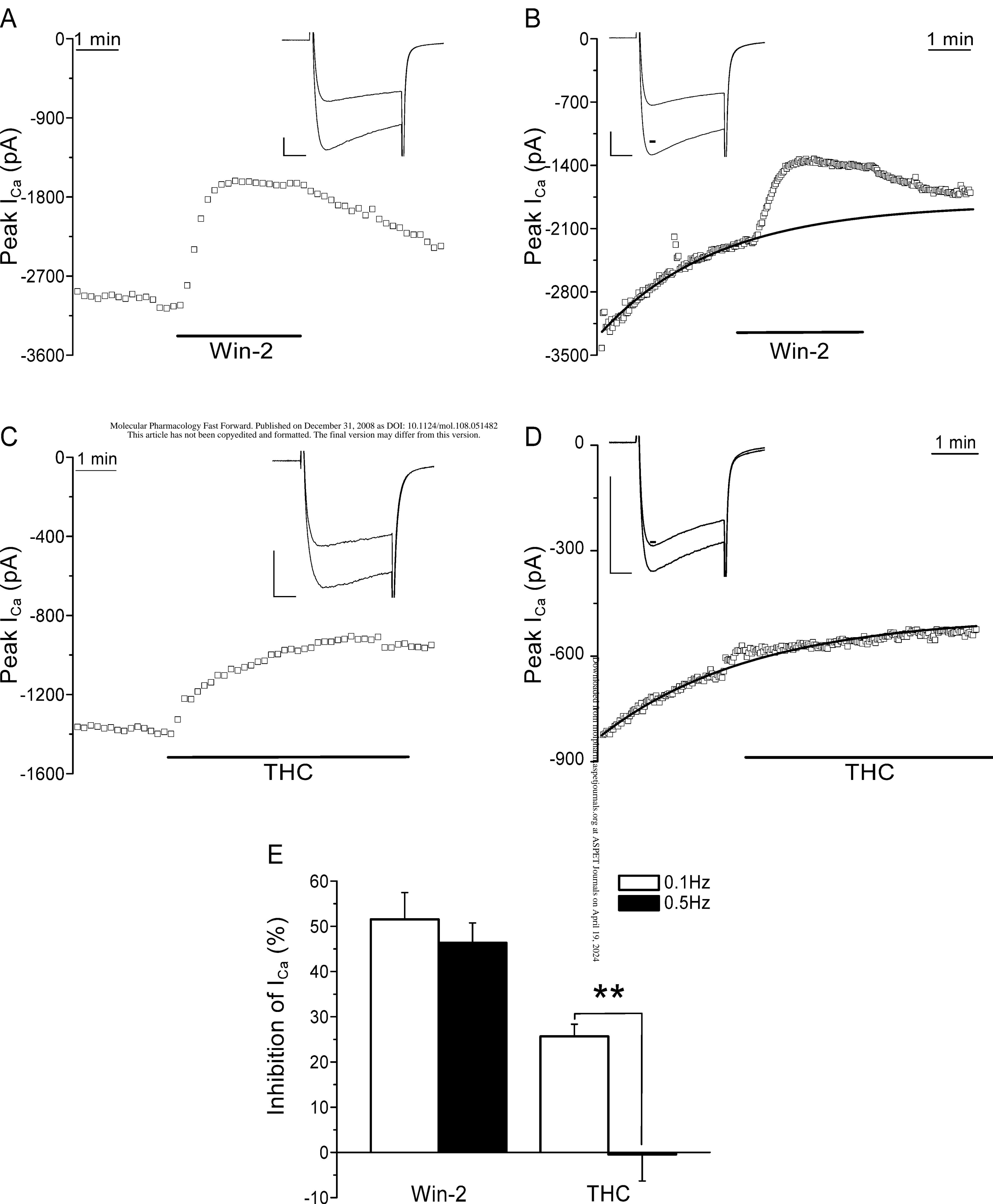

Fig 5

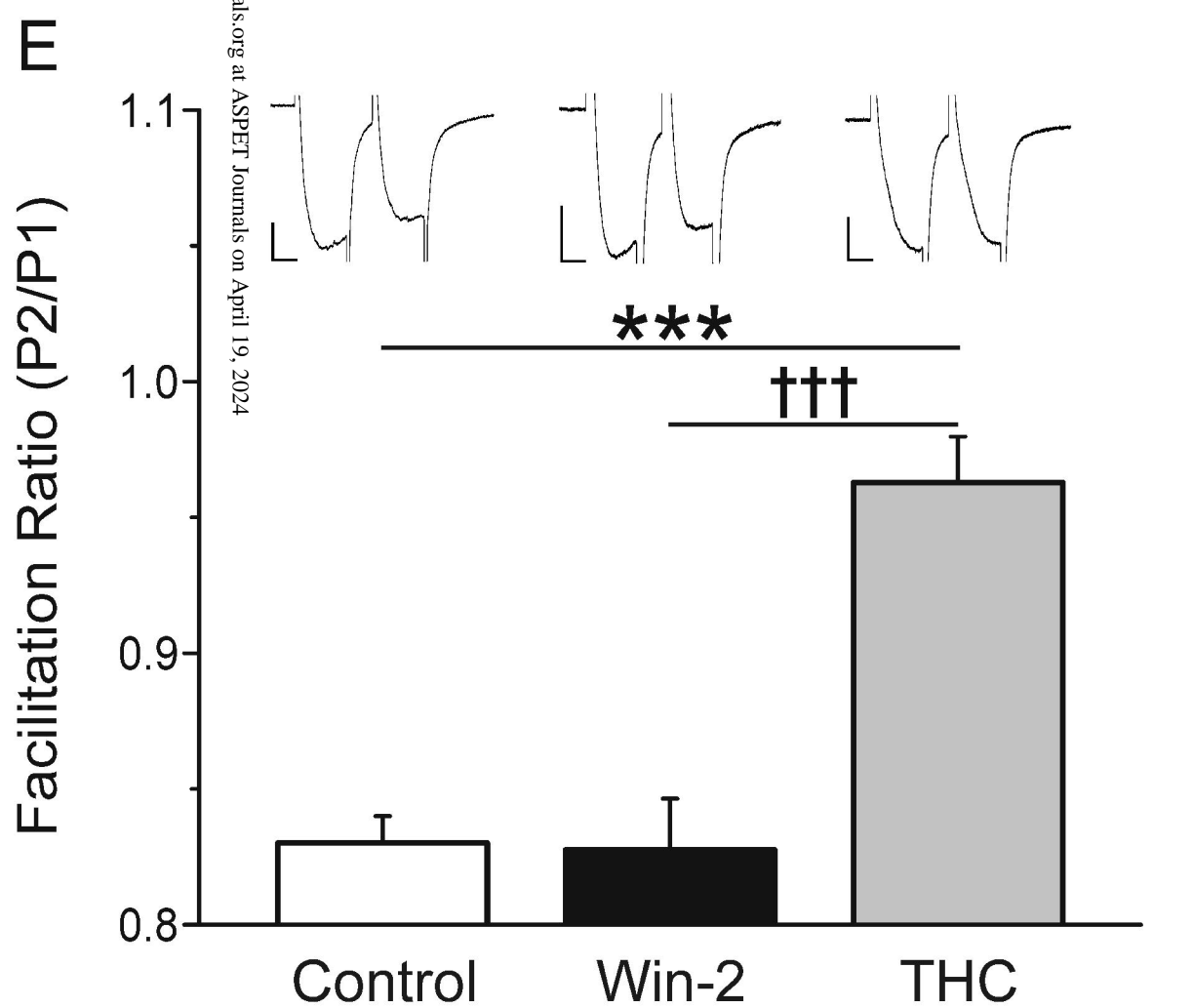
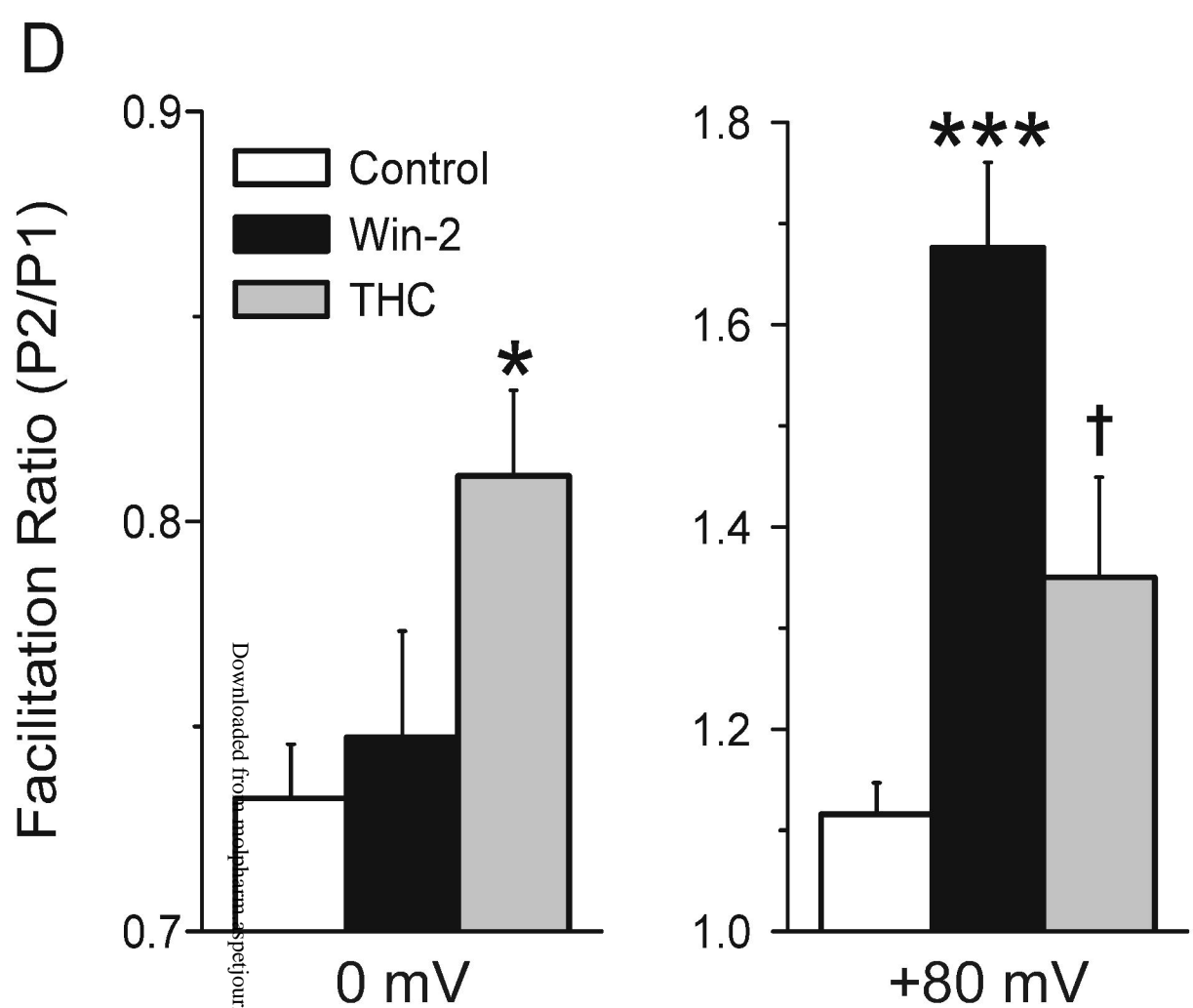
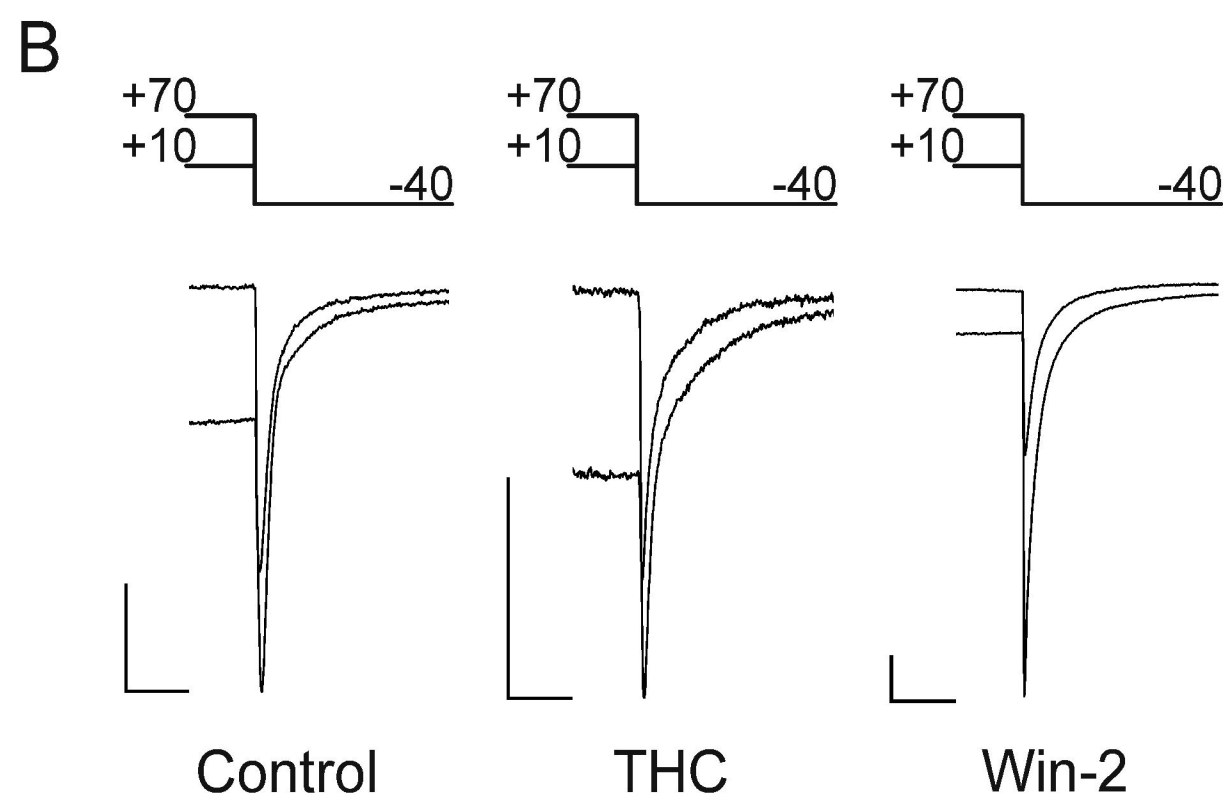
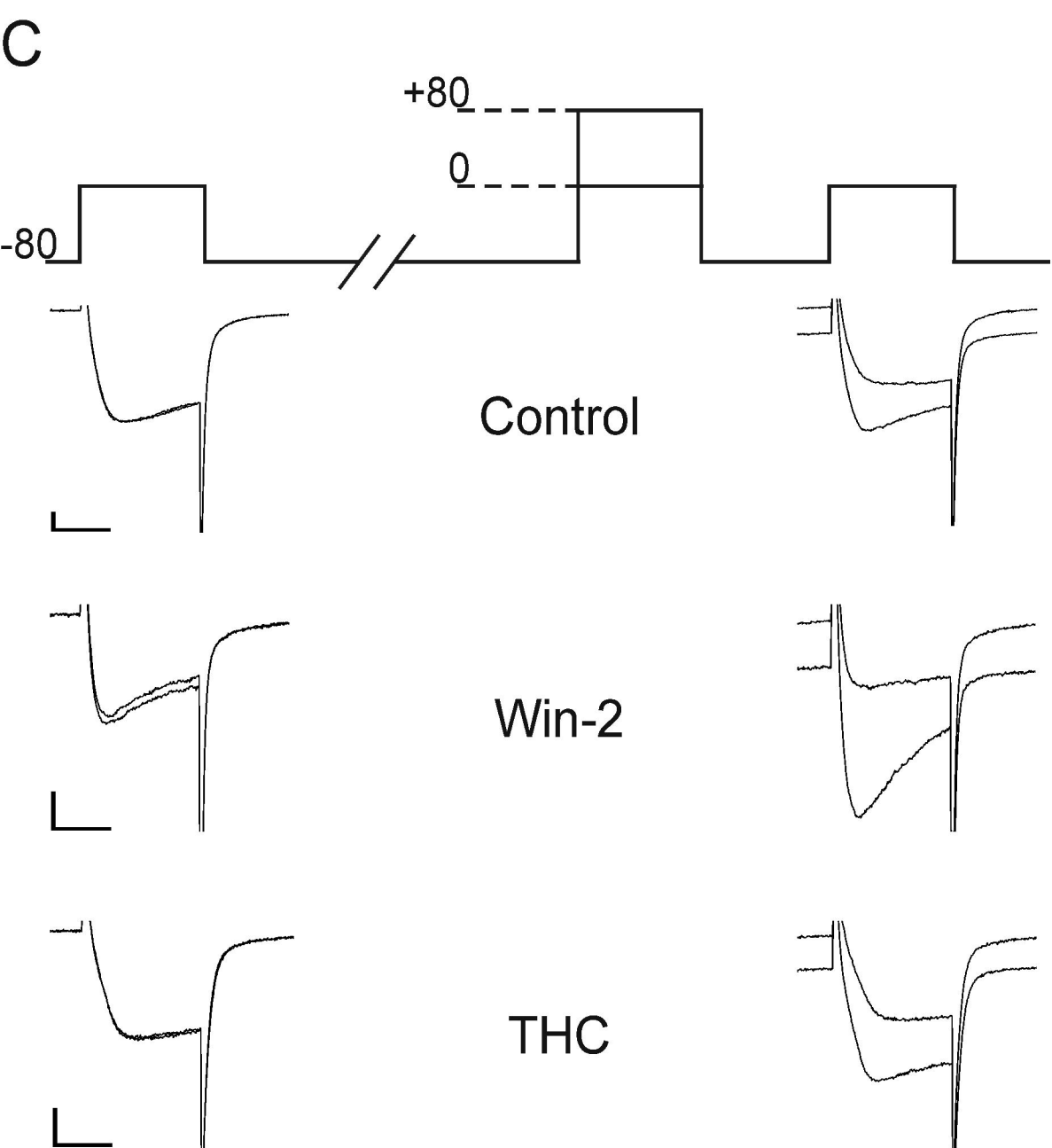
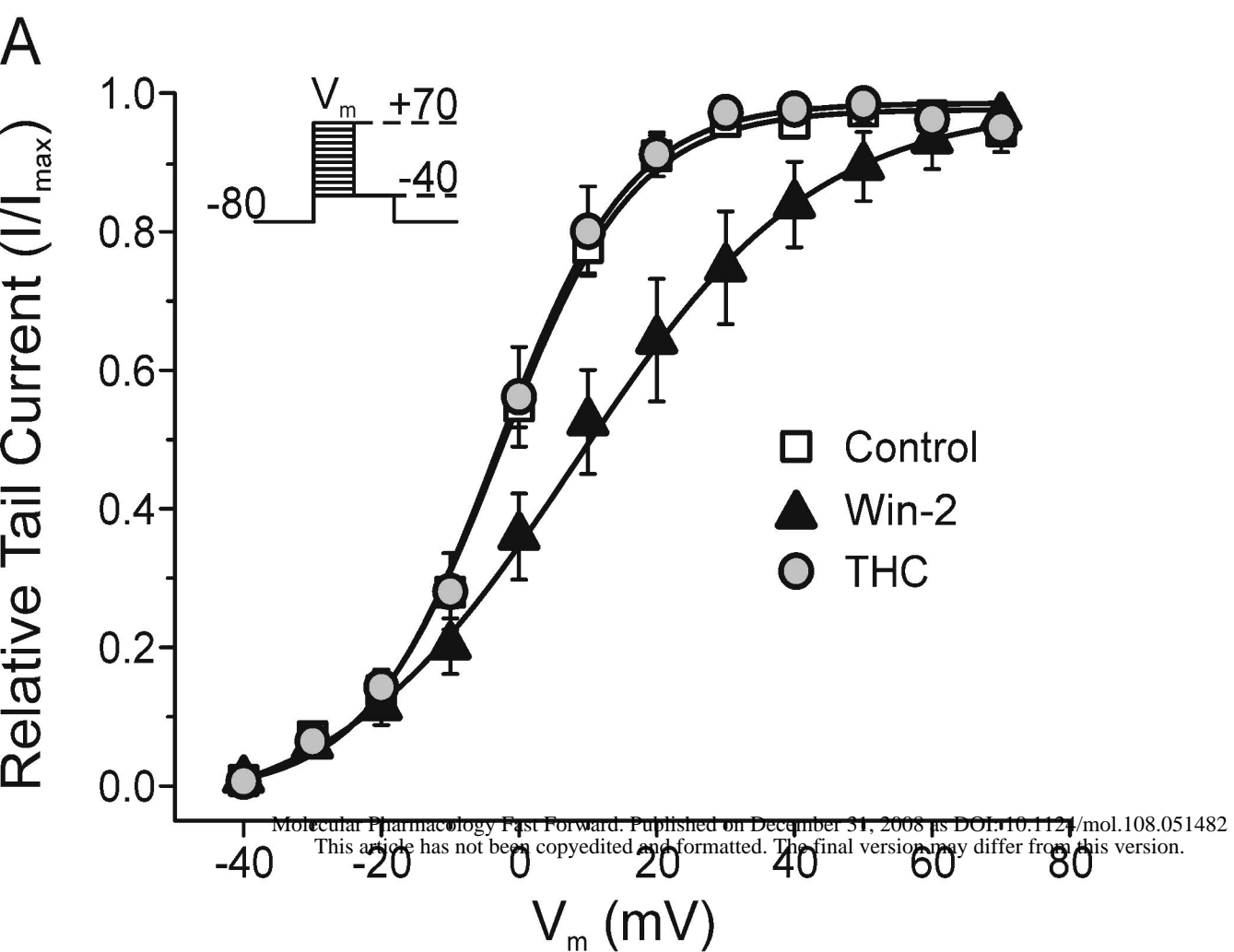

Fig 6

